



GRIZZLETM EV charger

EXTREME EDITION

User Manual & Installation Guide



Grizzl-E Extreme Edition Manual



Grizzl-E Home EV Charging Station – Extreme Edition

The Grizzl-E Extreme Edition is a simple, powerful, heavy-duty and portable electric vehicle charging station made in Canada and built to withstand the harshest conditions.

Grizzl-E Extreme Edition comes exclusively with a Premium 24ft cable which remains flexible in cold temperatures. Internal design and components of the charger have been selected to provide maximum operational life of the device and be able to withstand the elements.

Grizzl-E provides up to 10 KW of power to your vehicle. Physical switches inside can be set to provide 16 Amps, 24 Amps, 32Amps or 40 Amps adjustable maximum current.

IMPORTANT SAFETY INSTRUCTIONS

This document contains instructions and warnings that must be followed when installing and using the GRIZZL-E Extreme Edition Electric Vehicle Supply Equipment (EVSE). Before installing or using the EVSE, read this document including any WARNING and CAUTION symbols.

The symbols used have the following meaning:



Warning: risk of personal injury



Warning: risk of fire



Warning: risk of electric shock



Caution: risk of damage to equipment

- This document provides instructions for the charging station and should not be used for any other product. Before installation or use of this product, review this manual carefully and consult with a licensed contractor, licensed electrician, or trained installation expert to ensure compliance with local building codes and safety standards.
- Consult a licensed electrician to ensure that you can safely install and use this product.
- Ensure that the materials used, and the installation procedures, follow local building codes and safety standards.
- The information provided in this manual in no way exempts the user of responsibility to follow all applicable codes or safety standards.

OVERALL WARNINGS & CAUTIONS

Basic precautions should always be followed when using electrical products, including the following:

- Read all the instructions before using this product.
- Children should not use this device.
- Do not put fingers into the EV connector.
- Do not touch live electrical parts.
- Do not use this product if the flexible power cord or EV cable is ragged, has broken insulation, or any other signs of damage.
- Do not use this product if the enclosure or the EV connector is broken, cracked, open, or shows any other indication of damage.
- Improper connection of the equipment grounding conductor can result in a risk of electric shock. Check with a licensed electrician if you are in doubt as to whether the product is properly connected and grounded.

Repair and Maintenance Clause

- All United Chargers products do not require routine maintenance however, periodic inspections should be conducted to ensure that all parts remain in good working order and no damage exists.
- Do not attempt to open, disassemble, repair, tamper with, or modify any components of the products. Contact United Chargers for any repairs.



WARNING: This equipment is intended only for charging vehicles that do not require ventilation during charging. Please refer to your vehicle's owner's manual to determine ventilation requirements.

FCC Declaration of Conformity

This charging station complies with part 15 of the FCC Rules. Changes or modifications the charging station not expressly approved by the manufacturer could void FCC compliance.

Operation is subject to the following two conditions:

1. This charging station may not cause harmful interference
2. This device must accept any interference received, including interference that may cause undesired operation.



CAUTION: The service wiring in this section are specific to North America only. Before installing the Charging Station, identify the type of utility service connection onsite. If unsure about the type of connection available at the service panel, contact your utility service provider.



Product Features

GRIZZL-E™ Extreme Edition Electric Vehicle Charging Station (EVSE)

- J1772 AC Level 2 (208-240 VAC), 40A Continuous Rated (9.6 kW)
- Adjustable Maximum Current Output (40A, 32A, 24A, 16A) to Support Multiple Circuit Ratings (50A, 40A, 30A, 20A)
- Extreme Duty, Rigid & Compact Design
- Robust and heavy-duty aluminum cast case; airtight enclosure for indoor or outdoor use
- No user interface required with EVSE, simply Plug-in to your EV to initiate charging
- EasyEvPlug™ Holster and Tesla EasyEVPlug™ Holster with cable Management System
- Plug-in Configuration for easy portability
- Wall Mount with security features (including single stud mount), Pedestal, Bollard/Pole (Single & Dual Port) available from United Chargers
- Coupler Lock with Keys
- UL certified.

Adjustable Maximum Current Output to Support Multiple Circuit Ratings

The GRIZZL-E™ Extreme Edition Electric Charging Station features the ability to adjust the maximum charging station current output to allow the use of a 50A, 40A, 30A, or 20A Dedicated Circuit as follows:

50A Circuit Rating:	To support 40A (9.6kW) Maximum Charging Station Output
40A Circuit Rating:	To support 32A (7.68kW) Maximum Charging Station Output
30A Circuit Rating:	To support 24A (5.76kW) Maximum Charging Station Output
20A Circuit Rating:	To support 16A (3.84kW) Maximum Charging Station Output

The Default Factory Setting is 40A (9.6kW). To change the maximum current output, refer to Chapter 3.1 Adjust Maximum Current Output on page 12. If you are unsure of the circuit ratings in your home consult a licenced electrician.

Self-Monitoring and Recovery | Power Outage Recovery

When a charging session is interrupted due to a temporary error condition, the charging station will automatically restart charging when the cause of the temporary error condition returns to normal. Refer to Chapter 8.3 Self-Monitoring and Recovery (Auto Restart) on page 23 for more information.

Security and Tamper Feature

In addition to the security pin that secures the GRIZZL-E™ charging station to the wall mount bracket, the GRIZZL-E Extreme Edition also includes a coupler lock and key with a length of 90mm and diameter of 7mm.



Product Specifications

United Chargers GRIZZLE™ Electric Vehicle Charging Station (EVSE)

Description	Specifications
Model Number	GR1-1424PCC
Connector / EVSE Level	SAE J1772; AC Level 2
Max Output Rating	40A; 9.6 kW Maximum Output – For use with 50A Circuit Rating
Alternate Adjustable Output Ratings	32A; 7.68 kW Maximum Output – For use with 40A Circuit Rating 24A; 5.76 kW Maximum Output – For use with 30A Circuit Rating 16A; 3.84 kW Maximum Output – For use with 20A Circuit Rating
Charge Cable Length	24 ft. (7.2m)
Electrical Circuit / Input Power Requirements	Circuit Requirement: Dedicated Single Phase 208-240VAC, 50/60 Hz. Branch Breaker: Double pole. Circuit Conductors: Line 1, Line 2, Earth / Ground.
Input Power Connection	Standard: Plug-in NEMA 14-50 Plug. Plug is removable for Hardwire Connection.
Charging Station Color	Camo Style Design
Installation Rating	NEMA 4, Indoor/Outdoor Rated
Operational Ratings	Temperature: -22°F to 122°F (-30°C to 50°C); Humidity: 95% RH non-condensing
Mounting	Wall or Pedestal Installation
Overall Dimensions	EVSE: 10.25 x 6.25 x 3.75 inches (26.0 x 16.0 x 9.3 cm)
Display & Indicators	LED Charge Status Indicators (Power/Ready, Charging, Fault)
Cable Management	Holster and Tesla Holster with cable management
Standards & Compliance	UL certified





INSTRUCTIONS Manual

United Chargers GRIZZL-E™ Electric Vehicle Charging Station (EVSE)

Contents

1. Introduction and Unpacking	10
2. Installation Planning and Service Wiring:	11
2.1 Electrical Source Requirements	11
2.2 Grounding Instructions	11
3. Adjustable Maximum Current Output to Support Multiple Circuit Ratings	12
3.1 Adjust Maximum Current Output	12
4. Calibrating the GRIZZL-E Unit (Optional)	15
5. Installation	16
5.1 Tools & Parts Required for Installation	16
5.2 Install the Charging Station	17
5.3 Install Holster	19
6. Input Wiring Connection (Optional Hardwire Connection)	20
7. Charging Status Indicators and Buzzers	22
8. Operation	23
8.1 Connect and Charge	23
8.2 Stop Charging	23
8.3 Self-Monitoring and Recovery (Auto Restart)	23
9. General Product Care and Use Information	24
10. Warranty	25

1. Introduction and Unpacking

This user manual applies to the GRIZZL-E™ EVSE for Plug-in Hybrid Electric Vehicles (PHEVs) and Electric Vehicles (EVs).

The following items are included in the Grizzl-e Extreme Edition Package:

1

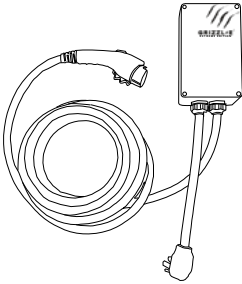

Charging Station with input and output cable (x1)

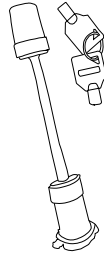

Coupler Lock and 2 Keys

2

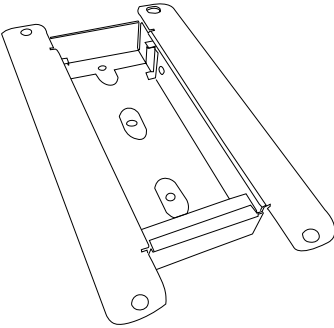

Mounting Bracket (x1)



Security Pin (x1)



Socket cap screw (x4)



Robertson Head Screws (x2)

3

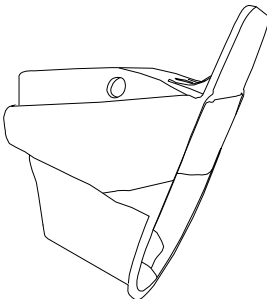

Holster (x1)

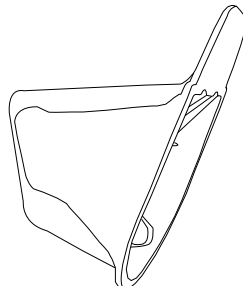

Tesla Holster (x1)



Philips-head screw (x8)

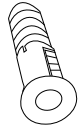

Anchor (x8)

2. Installation Planning and Service Wiring:



WARNING: Disconnect the power supply to the charging station before installing, adjusting, or repairing the charging. Failure to do so may result in physical injury or damage to the power supply system and the charging station.



CAUTION: To reduce the risk of fire, connect only to a circuit provided with the minimum branch circuit overcurrent protection requirements in accordance with the National Electrical Code ANSI/NFPA 7- and the Canadian Electrical Safety Code, Part 1, C22.1. If you are unsure if your circuit meets these requirements consult a licensed electrician.

2.1 Electrical Source Requirements

- Prior to mounting, locate an available electrical source that can support the following Input Requirements for the Charging Station Per local Electrical Safety Code requirements:
 - » 40A Maximum Output Setting (Default Factory Setting): a DEDICATED CIRCUIT rated for 50A; 208-240 VAC, 50-60 Hz, Single Phase must be used.
 - » 32A Maximum Output Setting (Optional Setting): a DEDICATED CIRCUIT rated for 40A; 208-240 VAC, 50-60 Hz, Single Phase must be used.
 - » 24A Maximum Output Setting (Optional Setting): a DEDICATED CIRCUIT rated for 30A; 208-240 VAC, 50-60 Hz, Single Phase must be used.
 - » 16A Maximum Output Setting (Optional Setting): a DEDICATED CIRCUIT rated for 20A; 208-240 VAC, 50-60 Hz, Single Phase must be used.
- A Double Pole Circuit Breaker of the circuit rating must be used.
- The Charging Unit has a built in GFCI protection; do not provide any additional GFCI protection upstream of the charging unit.
- The Charging Stations can connect a Standard NEMA 6-50 or 14-50 Receptacle or the unit can be hardwired

2.2 Grounding Instructions

The charging station must be implemented equipment grounding through a permanent wiring system or an equipment grounding conductor. Use a cable with a dedicated grounding conductor connected to the equipment ground terminal block.

3. Adjustable Maximum Current Output to Support Multiple Circuit Ratings

The GRIZZL-E™ charging station features the ability to adjust the maximum current output to support 50A, 40A, 30A, or 20A Dedicated Circuit ratings as follows:

Circuit Rating	Maximum Charging Station Output
50A	40A (9.6 kW)
40A	32A (7.68 kW)
30A	24A (5.76 kW)
20A	16A (3.84 kW)

- The Charging Station Default Factory Maximum Current Output Setting is 40A (9.6 kW) for use with a 50A Circuit Rating.
- To obtain the fastest charging capability of 40A, a 50A Circuit Rating must be used.
- The Circuit must be a DEDICATED CIRCUIT 208-240 VAC, 50-60 Hz, Single Phase.
- Requirements govern that only 80% of the circuit rated load may be utilized, hence the higher Circuit Ratings Requirement relative to maximum Charging Station output.

3.1 Adjust Maximum Current Output

To adjust the Maximum Current Output Setting:

1. Place the Charging Station on a flat surface with the front cover facing up.
2. Remove the front cover by removing the 4 screws at each corner of the charging station.



Figure 3-1. Four screws to remove the Charging Station Cover.



CAUTION: The LED pipe is attached to the front cover. When the front cover is removed, place it on a flat surface facing down to avoid damage to the LED pipe.

3. With the front cover placed to the side, locate the DIP switch on the charging station circuit board. The DIP switch is a 3-position switch on the main circuit board, located directly to the left of the LED.

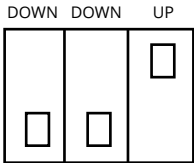
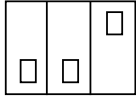
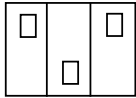
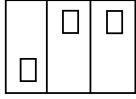
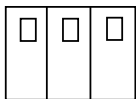

Figure 3-2. 3-DIP Switch Position



WARNING: Do not touch live electrical parts. Disconnect the power supply to the charging station and verify no power is present before adjusting the DIP Switches. A non-conductive object **MUST** be used to adjust the DIP switch settings. Failure to do so may result in physical injury or damage to the power supply system and the charging station.

4. Using a non-conductive object adjust the Maximum Current Output to either 32A, 24A or 16A, using the following combination of DIP switch settings:

Maximum Current Output	DIP 3	DIP 2	DIP 1	DIP Switch Setting (Picture)
40A Maximum Current Output (Factory Default Setting)	DOWN	DOWN	UP	 <p>Figure 3-3</p>
32A Maximum Current Output	UP	DOWN	UP	 <p>Figure 3--4</p>
24A Maximum Current Output	DOWN	UP	UP	 <p>Figure 3-5</p>
16A Maximum Current Output	UP	UP	UP	 <p>Figure 3-6</p>

5. Once the DIP Switch Setting is adjusted, reassemble the charging station. Reinstall the top cover to the charging station using the following torque force to secure the (4) socket cap screw:

Screw	Torque
M6	16 kgf-cm 13.88 lb-in

4. Calibrating the GRIZZL-E Unit (Optional)



WARNING: Electrical Power MUST remain OFF and DISCONNECTED before setting or changing the DIP switch. Incorrect connection may cause electric shock.

Note:

Calibration should be done before adjusting the charging station's maximum current output settings.

Calibration Steps:

1. Remove the front cover by removing the 4 screws at each corner of the charging station. For more information on how to remove the front cover refer to Chapter 3. Adjustable Maximum Current Output to Support Multiple Circuit Ratings on page 12.
2. Using a non-conductive object, calibrate the Grizzl-E unit by adjusting the DIP switch settings as follows:

Calibrate the GFCI Offset UP DOWN DOWN

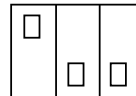

Figure 3-8

3. Close the lid, and re-secure the screws.
4. Power ON the supply unit until the front LED light turns solid red LED. The solid red LED indicates that the calibration is finished.
5. Once calibration is complete, follow the steps from the user manual to set the maximum current output. Refer to Chapter 3.1 Adjust Maximum Current Output on page 12.



5. Installation

5.1 Tools & Parts Required for Installation

Prior to mounting, determine the location of an acceptable mounting support. All charging station products must be anchored into a mounting support such as a 2" x 4" stud or a solid concrete wall. **DO NOT** mount this unit directly to a stucco/drywall/wall board.

Tool	Size	Source of Supply	Remark
Mounting Bracket	255 x148 x 36 mm	Included with Product	For mounting the charging station to the wall/structure
Socket cap screw (x4)	5/16"	Included with Product	For securing the charging station to the Mounting Bracket
Robertson-Head Screw (x2)	#14	Included with Product	For installing the Mounting Bracket to the wall/structure
Holster/Tesla Holster™	58 x 58 x 70 mm	Included with Product	To store the EV charging Plug and Cable
Phillips-Head Screw (x8)	#8	Included with Product	For installing the EasyEvPlug™ to the wall/structure
Anchors (x8)	#8	Included with Product	For installing the EasyEvPlug™ to the wall/structure
Philips Screwdriver	PH3	Commercially Available	For Holder Installation and Optional Hardwire Install
Allen key	M4	Commercially Available	For Charging Station Cover Screws
Allen key	3/16"	Commercially Available	For installing the enclosure plate to the back of the station body.

Table 2-1 Tools & parts required for installation

5.2 Install the Charging Station

1. Separate the front and back piece of the mounting bracket by pushing down on the notch.

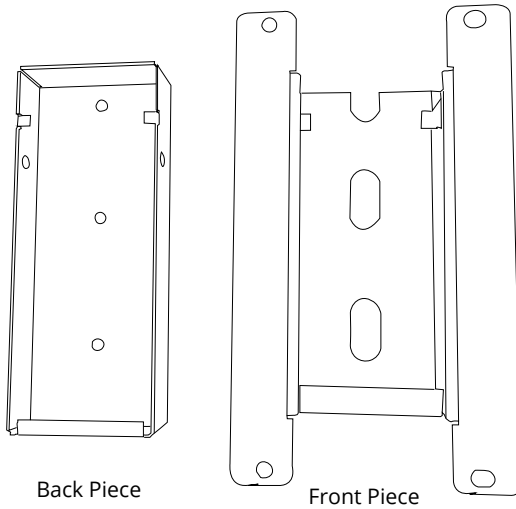

Figure 5-1. Mounting bracket

2. Attach the front piece of the mounting bracket to the back of the charging station using the Socket-cap screws. Ensure the top of the mounting bracket is matched with the top of the charging station.

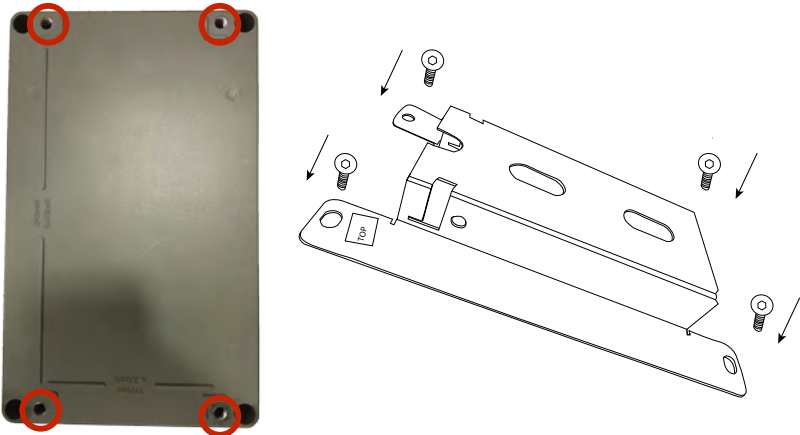

Figure 5-2 Back of Charging station and mounting bracket

- Secure the back piece of the mounting bracket to the wall or other suitable structure using the Robertson-head screws.

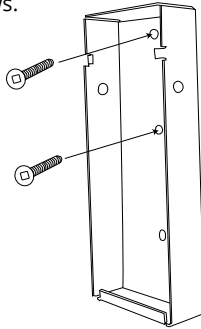

Figure 5-3 Back Piece of Mounting Bracket

The back piece of the mounting bracket has 3 holes to support attachment to various surfaces. Use the top two holes to attach the back piece of the mounting bracket to a wall stud.

Mounting Screw Recommendations:

- For finished walls supported by wood studs, use #14 or M6 tapping screws. (Included).
- For masonry walls, use M6 mechanical screws. (Commercially available)
- Use following torque force:

Screw	Torque
M6	50 kgf-cm 43.4 lb-in
1/4"	50 kgf-cm 43.4 lb-in

- Mount the charger on the wall by securing the front piece of the mounting bracket to the back piece of the mounting bracket.
- Secure the charger in place by inserting either the security pin or coupler lock into the mounting bracket.

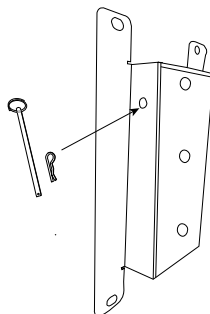

Figure 5-4. Security pin

6. Plug in the power cord to the NEMA 14-50 Wall Outlet/Receptacle. The NEMA outlet should be located no less than 20~26" from the ground or as defined by applicable, local electrical safety codes and standards.

5.3 Install Holster

The EasyEVPlug™ Holster or Tesla EasyEVPlug™ Holster is the new innovative method to protect your plug and manage your cord. It has the following features:

- No need to aim – flawless plug even in the dark.
- Your EV holster will always be in a convenient location.
- Saves space – special angle for less wall clearance.
- Integrated cable management – holds up to 25 feet of cable.
- Safety – use simple coupler lock to prevent unauthorized use (only on J1772 holster).

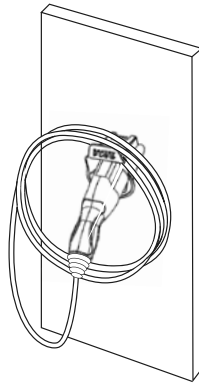

Figure 5-5. EasyEvPlug™

1. The Holster or Tesla holster can be installed at any location near the charging station. Once the location is determined hold the flat side of the against the wall with the label facing up.
2. Secure the holster with the Philips-head screws. Use the anchors if attaching directly into the drywall.

6. Input Wiring Connection (Optional Hardwire Connection)

1. Choose the appropriate conduit in accordance with all applicable, local and electrical safety codes and standards.



Figure 6-1. Conduit.

2. Using the appropriate tool, clamp the wire terminal to the copper wire. For non-insulated terminals, use heat shrink tube to cover the non-insulated portion of the terminal.



Figure 6-2. Copper terminal, heat shrink tube and copper wire

3. Remove the front cover by removing the 4 screws at each corner of the charging station. For more information on how to remove the front cover refer to Chapter 3.1 Adjust Maximum Current Output on page 12.
4. With the front cover placed to the side, use Philips screwdriver to release terminal screws of the or 14-50 Plug cable. Loosen the Strain Relief Fitting for the or 14-50 Plug and Remove the Plug. Remove the Strain Relief connector.
5. Insert the wire end passing through the conduit and insert them into the input wiring hole. (Use Red wire for L1, Black wire for L2, Green wire for G). Attach the copper wire on the corresponding terminal block. Use the following wire and torque force when connecting to input terminal block.

Model	Terminal	Conductor	Screw	Rating	Torque
GRIZZL-E™	L1, L2, G	8 AWG	M4	90C, copper wire	16 kgf-cm 13.88 lb-in



Figure 6-3. Input wiring



CAUTION: To reduce the risk of fire, connect only to a circuit provided with the appropriate amperes minimum branch circuit overcurrent protection in accordance with the National Electrical Code, ANSI/NFPA 70, and the Canadian Electrical Code, Part I, C22.1.









Model	Current Setting	Circuit Rating Requirement
GRIZZL-E™	40A	50A
GRIZZL-E™	32A	40A
GRIZZL-E™	24A	30A
GRIZZL-E™	16A	20A

- Once the input wiring and conduit are connected, reassemble the charging station. Reinstall the charging station front cover using the following torque force to secure the (4) Torx screws:

Screw	Torque
M4	16 kgf-cm 13.88 lb-in

7. Charging Status Indicators and Buzzers

Table 7-1 Charging status indicators

LED Indicator	Buzzer	Description	Definition
	No buzzer	Not illuminated	Power Off
	No buzzer	White	Initialization
	No buzzer	Blue Steady	Ready
	No buzzer	Blue Flashing	Vehicle detected
	No buzzer	Green Flashing	Charging in progress
	No buzzer	Green Steady	Charging complete or no current consumed by the car
	Buzzer sounds continuously	Red Steady	Unrecoverable Fault
	Buzzer beeps for 5 times and then stays off	Red Flashing	Recoverable Fault

Note:

In the instance the “Red Steady” or “Red Flashing” Fault light remains, it is recommended that you:

1. Unplug the charging Connector from your EV
2. Turn off the power to the Charging Station by switching the upstream circuit breaker to the “OFF” position
3. With the circuit breaker in the “OFF” position, wait 1-2 minutes and then switch the upstream circuit breaker back to the “ON” position
4. Confirm the Fault light is no longer present. If the Fault light remains, please contact United Chargers.

8. Operation

8.1 Connect and Charge

Insert the charging Connector into the EV and ensure the connector is fully seated/locked in place. Once complete, the charging session will begin.

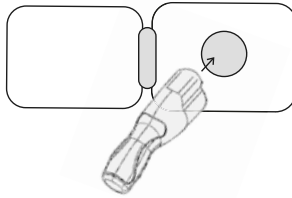

Figure 3-1. Connect the charging plug to the EV

8.2 Stop Charging

1. Unplug the charging station by pressing the connector button and removing the Charger Connector from the EV (once the connector button is depressed, the charging session terminates immediately).
2. Return the connector to the holster.

8.3 Self-Monitoring and Recovery (Auto Restart)

When a charging session is interrupted due to a temporary error condition, it will automatically restart charging when the cause of the temporary error condition returns to normal. The status indicator lights remain flashing RED until the error condition is resolved.

- Temporary error conditions include: Over Current, Under Voltage, Missing Diode, Ground Fault, and Over Temperature.
- For Over Current (OC) conditions: The charging session will be stopped while OC occurs. After recovery from OC for 30 seconds, the charging station will automatically restart charging for four times.
- When charging session stopped due to the Ground Fault (GFCI) trip, the charging station will try to restart after 15 minutes for 4 times. After 4 times, the charging station buzzer will stay on continuously, and status indicator will stay RED. The user should plug-out and plug-in the power cable of the charging station.



9. General Product Care and Use Information

The exterior of the charging station is designed to be waterproof and dust proof (NEMA 4 Outdoor Rated). However, periodic cleaning may be required, depending on local conditions. To ensure proper maintenance of the charging station, follow these guidelines:

- To avoid damaging the finish of the products, only use an automotive grade soft cleaning cloth with soap and water to remove accumulated dirt and dust. Do not use cleaning solvents to clean any of the product components.
- Despite the water resistance of the enclosure, directing a stream of water at the unit is not recommended.
- Ensure the charging connector is put back in the holster after charging to avoid damage.
- Ensure the power cable is stored on the charging station after use to avoid damage.
- If the power cable or the charging connector is damaged, turn off the charging station supply circuit breaker, do not use the charging station, and Contact United Chargers Customer Support for replacement parts.
- When moving or lifting the unit, always grasp and carry by the charging station body. Never attempt to lift, move, or carry the unit by any of the electrical cables. Improper handling may cause damage to the unit.



10. Warranty

GRIZZL-E™ Extreme Edition EV Residential Charging Stations 5 Years Replacement Warranty.

This warranty is extended by United Chargers to original purchasers of GRIZZL-E™ EV Charging Stations for residential use only. United Chargers warrants that this product is free from defects in materials for a period of 5 years and free from defects in workmanship under normal non-commercial use for a period of 5 years and commercial use for a period of 1 year from the date of purchase. Commercial use means station is used by more than one single family residence or drivers. No agent, employee, or representative of United Chargers has any authority to affirm, represent or warrant anything concerning GRIZZL-E™ EV Charging Stations, except for the affirmation and representation which is specifically included within this warranty.

This warranty will not apply if the product has been misused, abused, or altered. Warranty for the cable does not include normal tear and wear, also cables with plugs which have been exposed to snow or water for a prolonged amount of time are not covered by this warranty. The warranty will apply only if the product is defective. United Chargers shall make the final decision, in fairness to all concerned, as to the legitimacy of any such claim on this warranty. Upon discovery of any defective GRIZZL-E™, please contact our Customer Service Department for further instructions as to how to repair or replace the defective unit or log into your account at www.grizzl-e.com and submit support ticket.

United Chargers Inc
90 Gough Road, Unit 2
Markham, Ontario L3R 5V5 Canada

Phone: +1-833-840-4970
E-mail: info@unitedchargers.com
Website: www.grizzl-e.com

The most up to date and version of the manual is available on line at:
<https://grizzl-e.com/manuals/>